

# Complete Shower Room Installation Manual

8128  
SIZE:90\*90\*205cm



## Cautions in Installation and Using

Thanks for selecting our shower room series. To guarantee safe and normal operation as well as prolong service lifetime. Pls read Instruction carefully before installation.

Note: Constar is dedicated to improving products quality, find something new in what is old, we would if there is difference in the Instruction until further notice. Any discomfort, we beg your pardon.

### Directory







1、 Tool contents	-----	2
2、 Accessory list	-----	3-4
3、 Pipe and drain installation drawing	----	5
4、 Installation Procedure	-----	6-15
5、 Electric appliance instruction	-----	16-24
6、 Notes	-----	25
7、 Delivery and storage notice	-----	25
8 Trouble shootings	-----	26

## 7. Trouble shootings

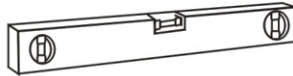



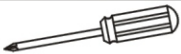

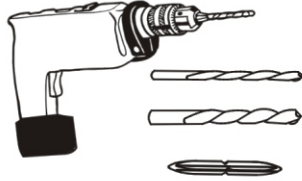



Troble	Cause	Remedy
No power	1. Electric power don't connect well, leak switch is cut off.	Access to power
	2. Fuse wire is broken, switch of control panel is failure.	Maintain or replace
	3. GFCI is out of work	Check GFCI
No head shower	1. water pressure is abnormal	Check water pressure
	2. Cold and hot water switch is closed.	Turn on the cold and hot water switch
	3. chocking nozzle	Clean
Water pipe leakage	1. Seal ring damaged	Replace seal ring
	2. Tie in don't connect well	Connect it again
No radio	1. Connecting wire is cut	Make connection
	2. Loudspeaker is broken	Replace a new one
Phone unuable	1. Telephone wire don't connect well	To make contact telephone line
	2. Control panel is broken	Maintain or replace
No light	1. Bulb is broken, ballast is broken	Replace
	2. Break of ballast	To make contact
	3. Control panel is broken	Maintain or replace
No exhaust	1. Fan is broken	Replace
	2. Tie-in is not connect well	To make contact
	3. Control panel is broken	Maintain or replace

If complete shower room cant work normally, please check it as compare above then obstacle avoidance.  
If customers cant make sure the cause of obstacle or lack of ability mantianance. Please contact distributer.

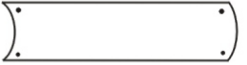
## 1、 Tool contents

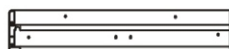
Name	self-provide tool
Track level bar	
tape measure	
Ajustable spanner	
Rubber hammer	
Phillips screwdriver	
Scissors	
Glass cement	
electric drill	
3mm aiguille	
6mm aiguille	
tap drill	

## 2、Accessory list

Items	Name	Accessory	Quantity
1	(1.1)Tub		1
	(1.2)Backboard		1
	(1.3)Roof		1
2	(2.1)Arch fixed door glass		2
	(2.2)Arch flexible door glass		2
3	(3.1)side upright column		2
	(3.2)upper rail		1
	(3.3)down rail		1
4	(4)Roller		8
5	(5)top shower head		1
6	(6)Handle		2

(3)

## 5. Notes

1. It is unadvisable to take a shower after drunk.
2. It is unadvisable to have a shower immediately after acute sports.
3. Please avoid bath or shower in morning.
4. Keep the temperature of dressing room near to the bathroomS
5. If you feel uncomfortable while having a shower , you should go out of the shower room as soon as possible.
6. The time of shower is advisable to be between 15 minutes and 20 minutes, no longer .
7. Drink water to supplement moisture after shower or bathing.
8. People who suffer from heart disease, high blood pressure, diabetes or who feel unwell or pregnant woman are unadvisable to have bathing ,massage or shower.

## 6. Delivery and storage notice

- 1,It is prohibited to store organic solvent together, such as formic acid and methanol.
- 2.Handle with care if it need transport.Heavy stress,mechanical impact and sharp pounding is prohibited.
- 3.It should keep it dry and airy and make sure there is no etchant gas.

(16)

## 4、Installation Procedure



10、 Connect cold and hot water pipes, and fix their connection head by spanner.

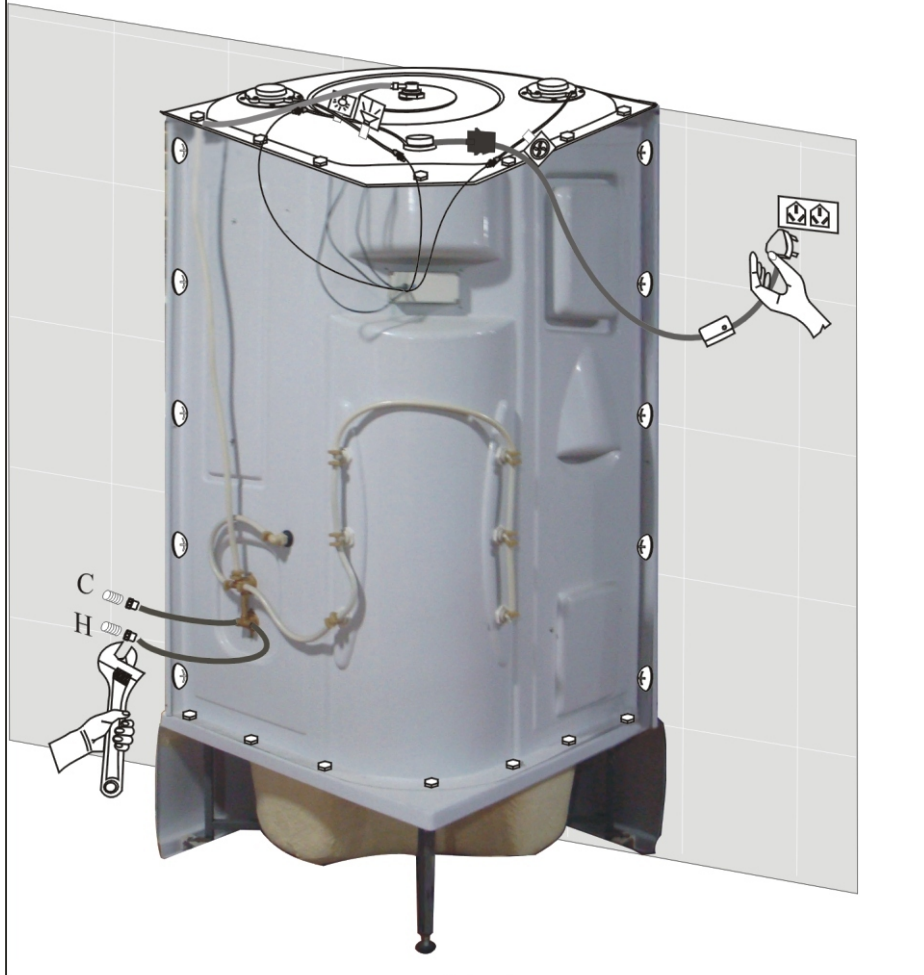

(15)

## 2、Accessory list

Items	Name	Accessory	Quantity
7	(7.1) handle shower		1
	(7.2) handle shower pipe		1
8	(8) handle shower pipe		2
9	(9) Hot and cold water pipe		2
10	(10.1) Glass positioning clip		4
	(10.2) Glass positioning fixture		8
11	(11.1) Magnetic strip		2
	(11.2) Waterproof seal		4
	(11.3) U style seal		2
12	(12.1) St 4*16mm screw		22
	(12.2) St 4*60mm screw		8
	(12.3) M 6*30mm nuts/bolts		14

(4)

### 3、 Pipe and drain installation drawing

C=Cold water inlet;  
H=Hot water inlet;  
D=Drain

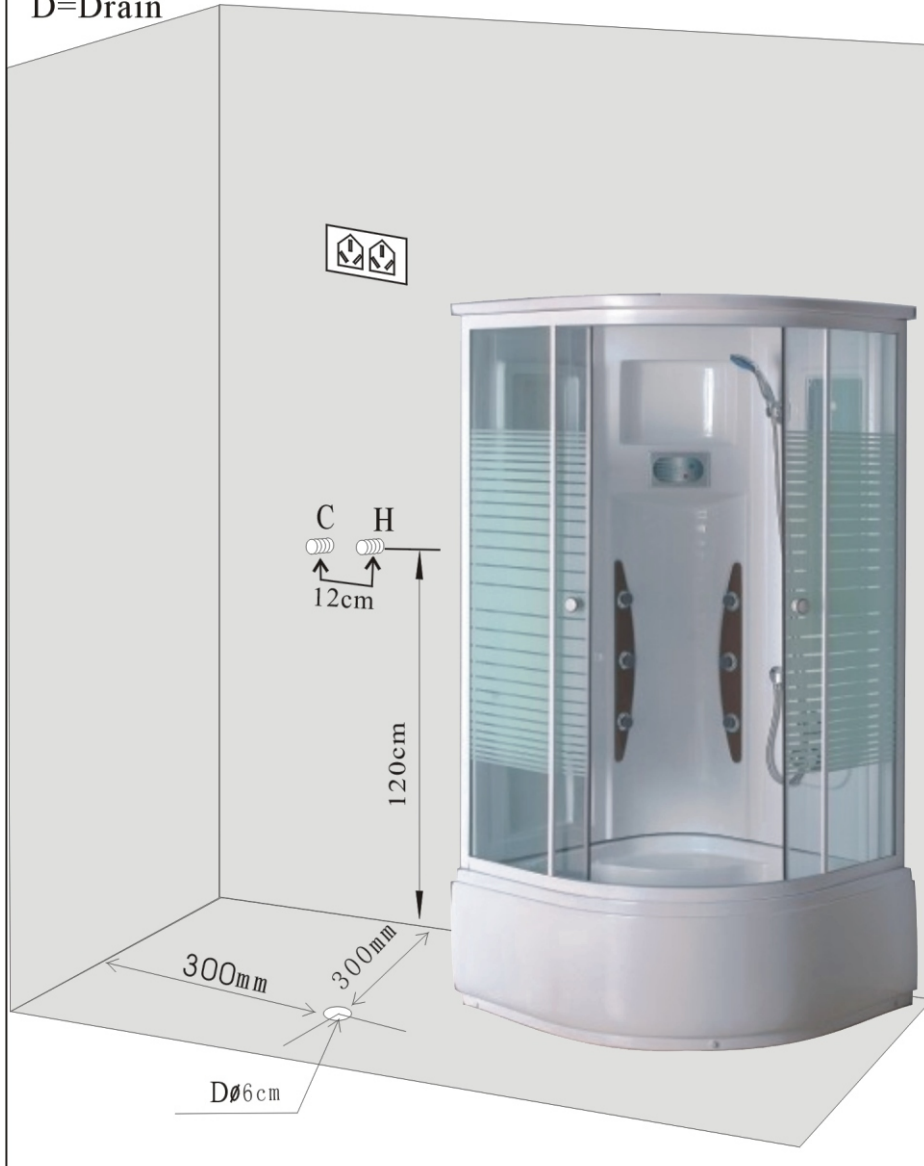

(5)

### 4、 Installation Procedure

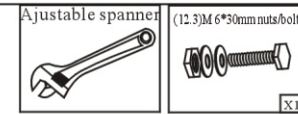

9、 Use M6\*30mm nuts/bolts and spanner to make shower room in shape.

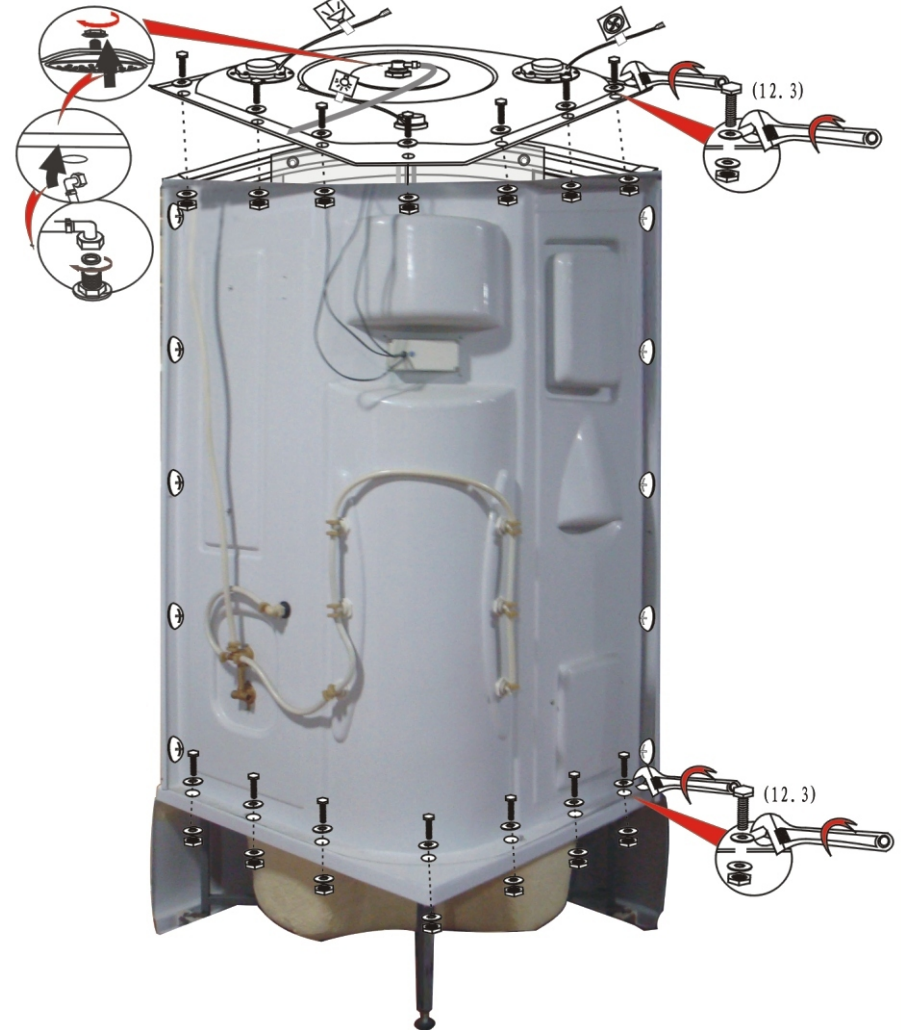

(14)

## 4、Installation Procedure

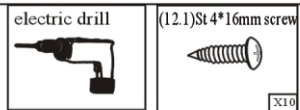

8、 Using power driller drives ST4\*16mm screw to connect backboard and side upright column.



(13)

## 4、Installation Procedure

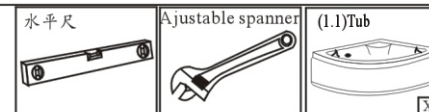

1、 Place the bath on a solid floor and adjust the feet so that it is level. Check carefully using a spirit level.

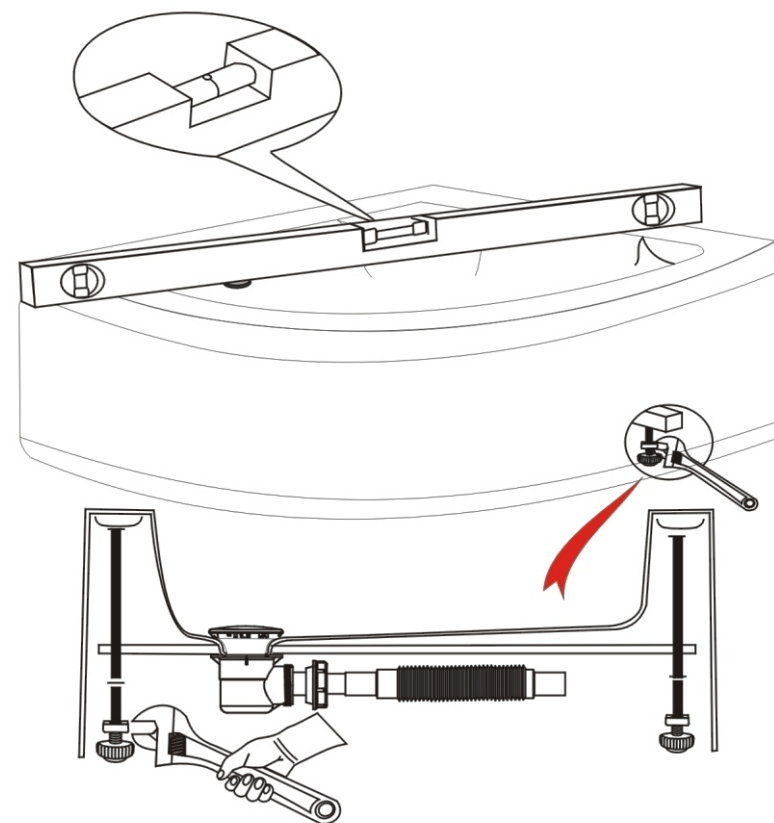

(6)

## 4、Installation Procedure

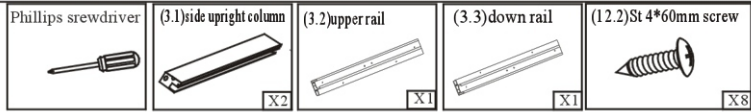

2、Installing the glass room frame. Take out item (3.2) , (3.3) and (3.1) ,and then connect them with the screws ST4\*60mm.

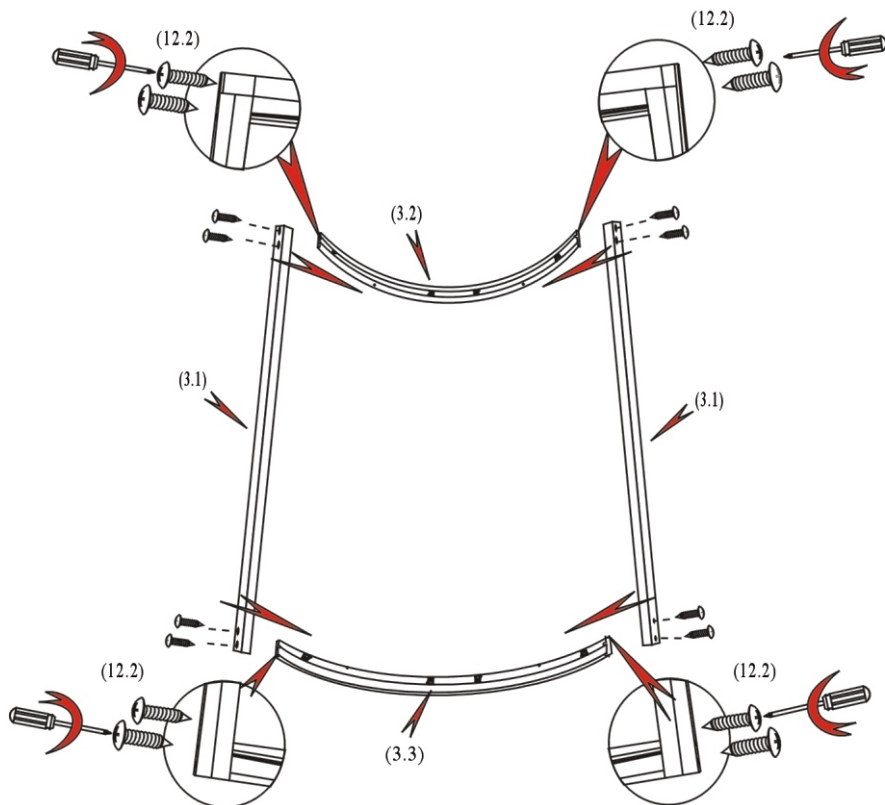

(7)

## 4、Installation Procedure

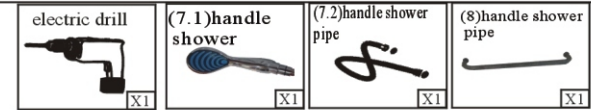

7、 Connect the glass room and back board,by screws.

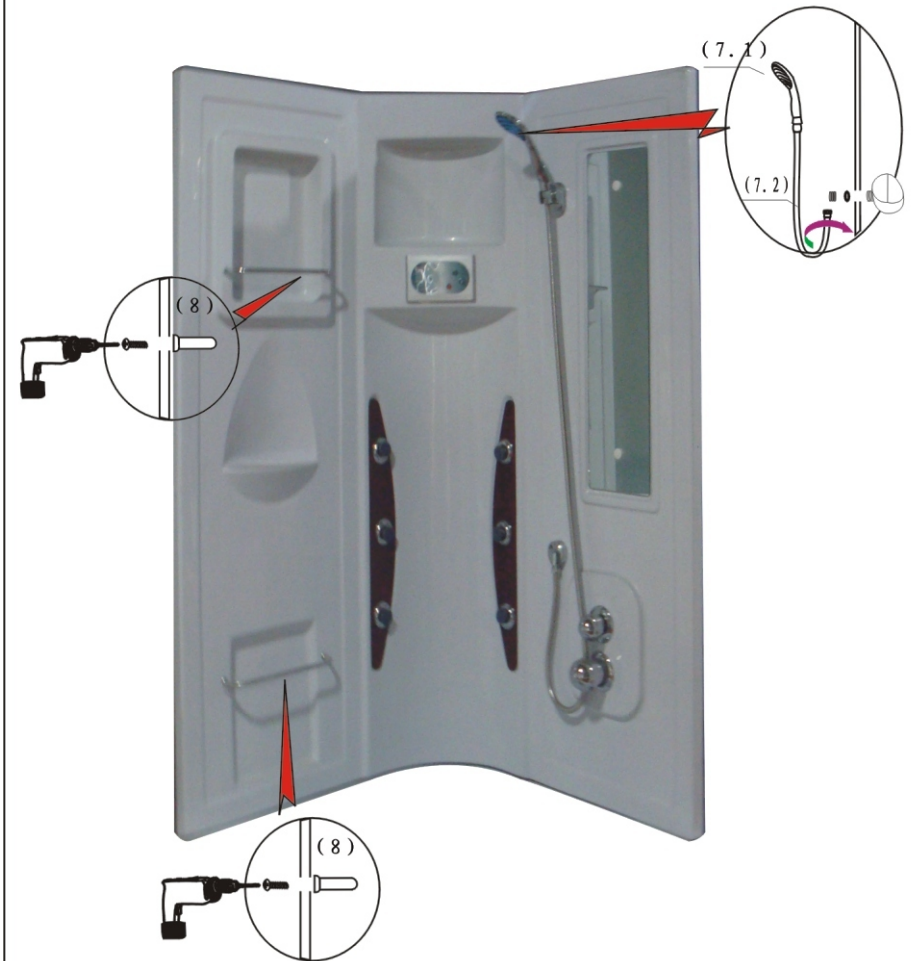

(12)



## 4、Installation Procedure

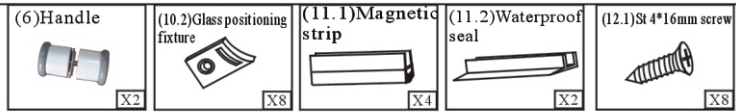

6、 Fit the handle into flexible door, fix rubber position by screws. Fit the magnetic seal and waterproof belt.

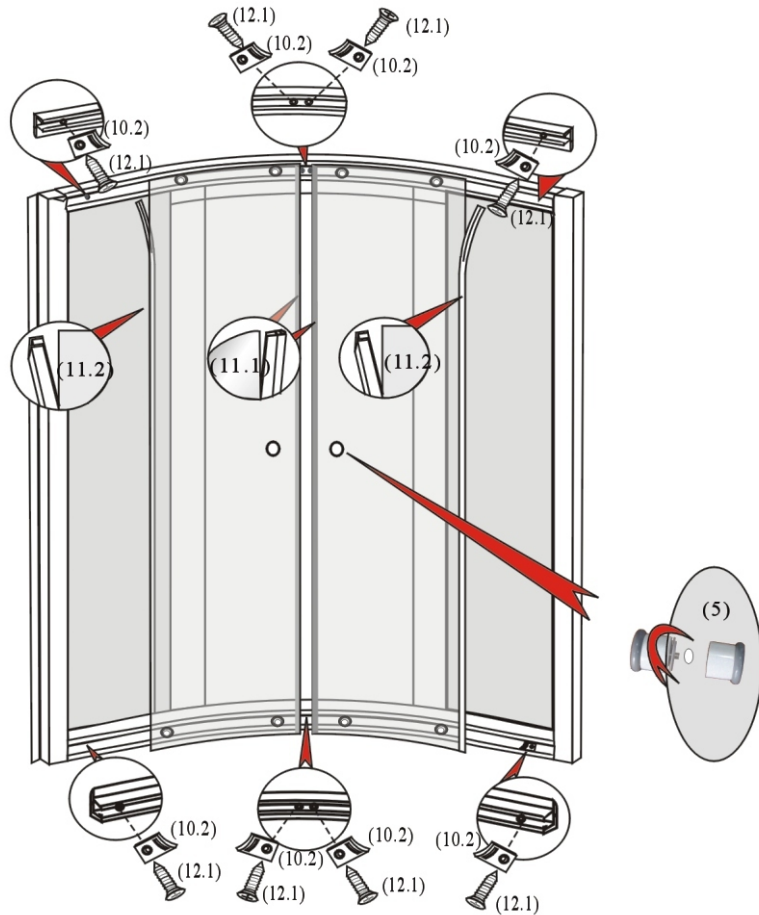

(11)

## 4、Installation Procedure

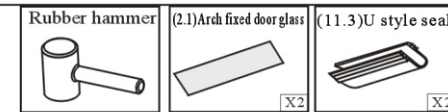

3、 Fit the plastic sealing strips to both sides of the fixed pieces of glass (the 2 pieces of glass without any holes). You may need to trim this down to make it fit, make sure it is no longer than the glass otherwise the glass will not fit.

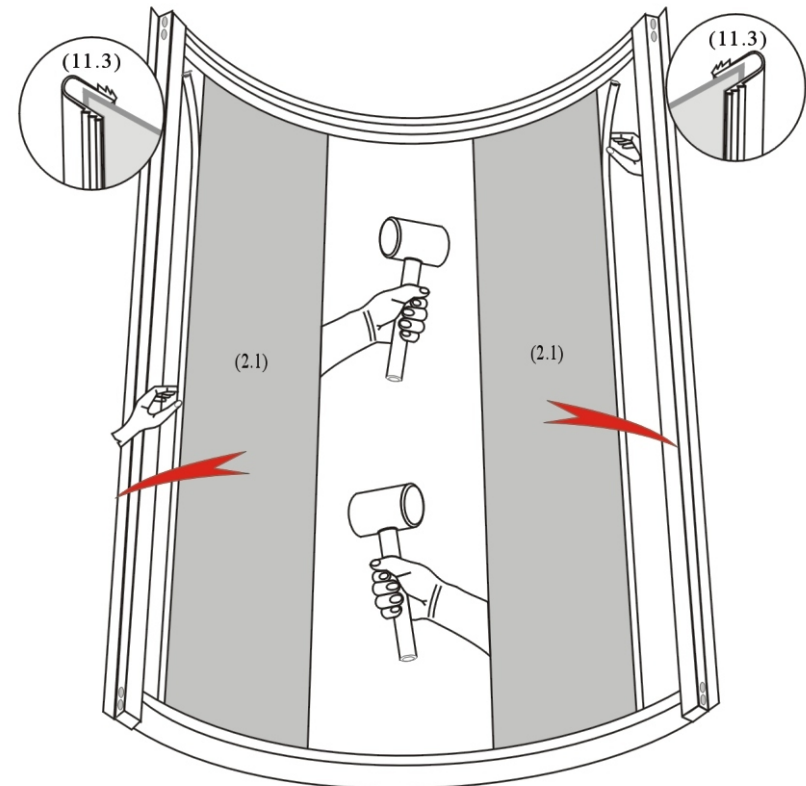

(8)

## 4、Installation Procedure

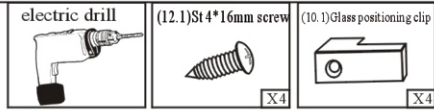

4、 Take out glass positioning clip, fit it with fixed glass, then drill ST4\*16mm screws to fix it into rails, to hold glass tightly.

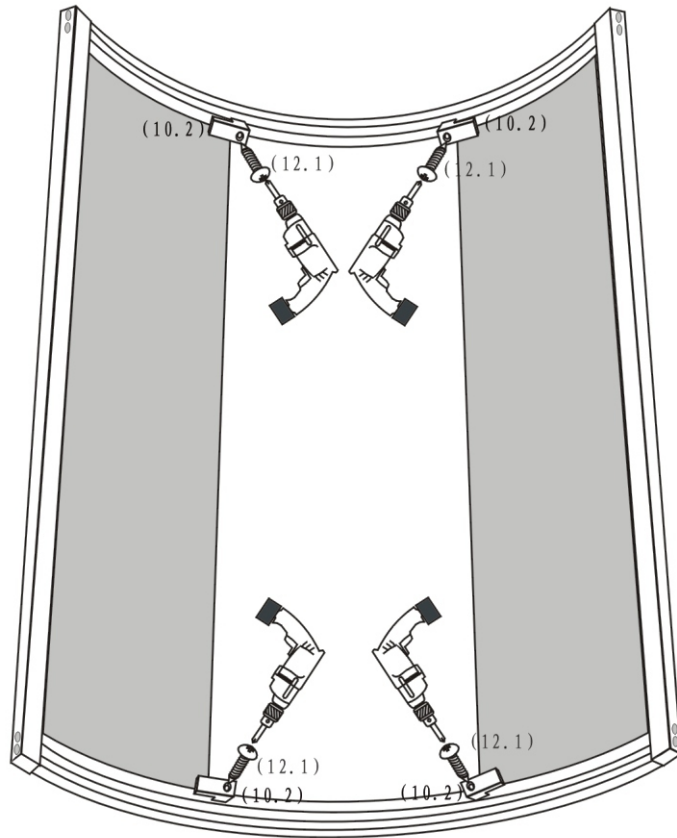

(9)

## 4、Installation Procedure

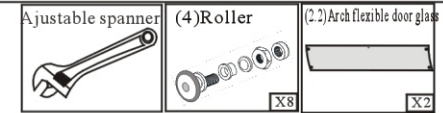

5、 Put the roller (6.4) into glass door holes, and adjust the roller screw, then hang the door into up rails. Then fix all of roller, to make sure the door move smoothly.

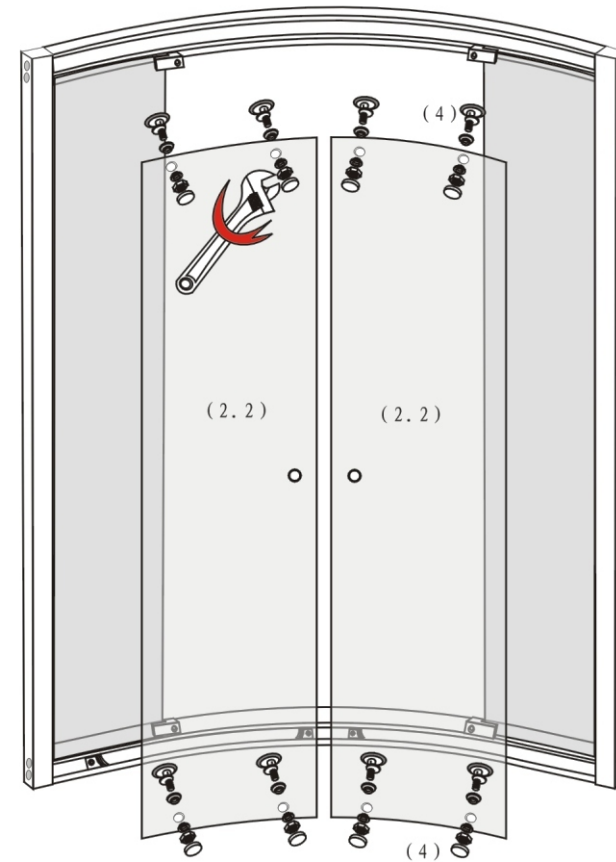

(10)